

Tower oscillation monitor

▶ **GEL 3011 CANopen**

Communication profile CiA 301

Device profile CiA 401

Reference

Fieldbus interface

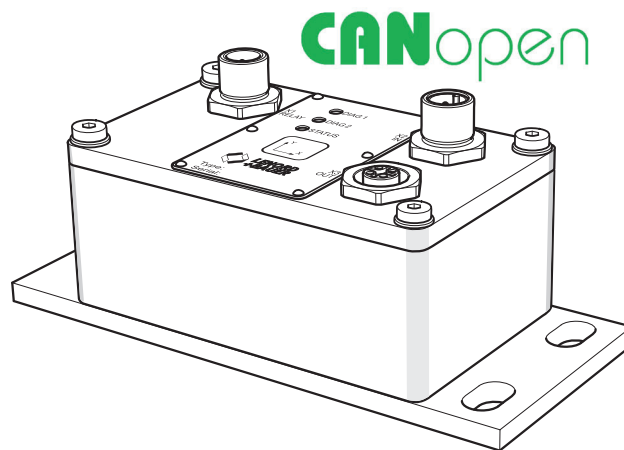

Device manufacturer and publisher:

Lenord, Bauer & Co. GmbH
Dohlenstrasse 32
46145 Oberhausen • Germany
Phone: +49 208 9963-0 • Fax: +49 208 676292
Internet: www.lenord.de • E-Mail: info@lenord.de

Doc. no. D-02R-3011CO (1.1)

Table of contents

1	General	5
1.1	About these instructions	5
1.2	Description	5
2	Connection and display elements	6
2.1	X1 – relay outputs	6
2.2	X2/X3 – bus input/output	6
2.3	Indicators	6
3	Object list	8
3.1	Communication parameters in accordance with CiA 301 (1xxxh)	8
3.2	Device parameters in accordance with CiA 401 (6xxxh)	13
3.3	Manufacturer-specific objects (2xxxh)	14
4	SDO communication	15
5	Emergency messages	17
5.1	Allgemein	17
5.2	Error codes	17
6	LSS functions	18
6.1	Setting node number	19
6.2	Setting baud rate	20
6.3	Writing settings to the flash memory	20

1 General

1.1 About these instructions

The following description covers the CANopen integration of the Turmschwingungssensor **GEL 3011 CO x x x x x x x**

It is aimed at persons who are already familiar with the principle of operation of a Schwingungssensor and who have a basic understanding of the CANopen fieldbus interface. For further information refer to the related standards published by the organisation *CAN in Automation* (CiA) (www.canopen.org).

You will find information on the function and usage as well as the technical data for the Turmschwingungssensor in the product information and the technical information (available in the download area at www.lenord.de).

Numerical data:

Unless explicitly stated, decimal values are given as integers without any additional information (e.g. 1408). Binary values are marked with a “b” (e.g. 1101b) and hexadecimal values with an “h” (e.g. 680h) after the integers.

Abbreviations and glossary:

The term **CO x ...** is part of the type code (order code) for the product and is not further stated in the following.

The terms **Sensor** and **Schwingungssensor** are used as synonyms for Turmschwingungssensor.

1.2 Description

The Turmschwingungssensor is designed as a CANopen slave in accordance with the communication profile CiA 301 and supports a large number of the objects defined in the device profile CiA 401. You can obtain a complete specification of the individual profiles from *CAN in Automation e.V.*:

- Protocol layer: *CiA 301 V4.2.0 – CANopen application layer and communication profile, February 2011* (EN 50325-4)
- Device profile: *CiA 401 V3.0.0 – CANopen device profile for generic I/O modules, June 2008*

The communication and device properties supported as well as the functions of the Sensor are defined in the related EDS file.

The Sensor is integrated into an existing bus line using two M12 connections.

If not otherwise stipulated by the customer, the following settings apply

- Transmission rate: 500 kbit/s
- Node ID: 1

2 Connection and display elements

2.1 X1 – relay outputs

X1 – Relaisausgänge

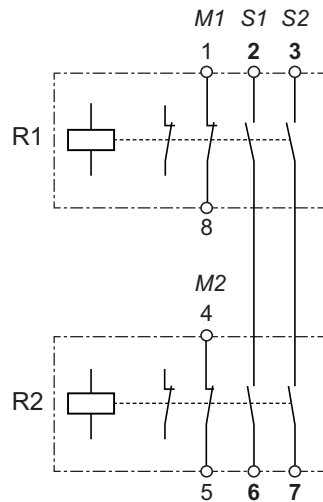

- R1, R2 Relays (redundant)
- M1, M2 Signalling contacts
- S1, S2 Safety contacts (safety circuits 1 and 2)

2.2 X2/X3 – bus input/output

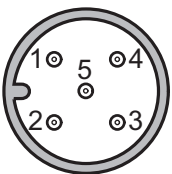

X2 IN (male)

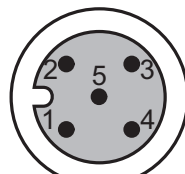

X3 OUT (female)

- 1 Screen
- 2 Supply voltage +V_S
- 3 GND
- 4 CAN_H
- 5 CAN_L

2.3 Indicators (1)

DIAG 1, DIAG 2 – switch states of relays R1 and R2



Limits exceeded, safety circuit open



Within the limits, but inhibit time active, safety circuit open



Normal operation, safety circuit closed













Hardware fault in the related branch, safety circuit open



Hardware fault in the redundant branch or communication error between the two branches, safety circuit open

(1) Representation on printing in black and white: ■ ≙ green, ■ ≙ red; the area shown covers a duration of approx. 4 seconds

STATUS – bus state

	<i>Init</i>
	<i>Stopped</i>
	<i>Pre-operational</i>
	<i>Operational</i>
	<i>Pre-operational, bus warning</i>
	<i>Operational, bus warning</i>
	<i>Pre-operational, bus passive</i>
	<i>Operational, bus passive</i>
	<i>Init, bus passive</i>
	<i>Bus off</i>

3 Object list

The object list contains all the CANopen properties supported by the Sensor. The data is in the device's non-volatile flash memory and are copied to the memory (RAM) on power-on or reset. If data in the object list is changed, the change is only made in the RAM. If the data is to be saved permanently, it must be transferred to the flash memory via the object 1010h. The original data will then be overwritten.

SDO services are used to access the object list.

The object list is divided into three areas:

- Communication parameters as per CiA 301
- Device parameters as per CiA 401
- Manufacturer-specific parameters

The entries in the object list are addressed using a 16-bit index. Each index entry can be further sub-divided using a subindex.

Information on the object list given below:

- Acc. (access type): ro = read only, rw = read and write
- (Data) type: Uxx = Unsigned xx (xx = 8/16/32 → 1/2/4 bytes without sign), Sxx = Signed xx (xx = 16/32 → 2/4 bytes with sign), STR = ASCII character string
- Sub = Subindex (type: U8)
- Bold (index): parameter can be saved (index 1010h) or loaded (index 1011h)

3.1 Communication parameters in accordance with CiA 301 (1xxxh)

Index	Designation	Acc.	Type	Meaning
1000h	<i>Device type</i>	ro	U32	870191h Profile 401 (191h), digital inputs/outputs + analogue inputs + manufacturer-specific PDOs (87h)
1001h	<i>Error register</i>	ro	U8	Bit 0: 1 = General error (Sensor alarm message) Bit 1–6: <i>Not used</i> Bit 7: 1 = Manufacturer-specific error

Index	Designation	Acc.	Type	Meaning												
1003h	<i>Pre-defined error field</i>	ro	U32	<table border="1"> <thead> <tr> <th>Sub</th> <th>Contents</th> </tr> </thead> <tbody> <tr> <td>00h</td> <td>Number ≤ 20 (type: rw)</td> </tr> <tr> <td>01h</td> <td>Last error</td> </tr> <tr> <td>02h</td> <td>Penultimate error</td> </tr> <tr> <td>:</td> <td></td> </tr> <tr> <td>14h</td> <td>First of the last 20 errors</td> </tr> </tbody> </table> <p>Clear error memory: 00h → Subindex 0</p> <p>Possible errors: 7300h = Sensor error 7301h = Relay error 8400h = Acceleration over alarm threshold</p>	Sub	Contents	00h	Number ≤ 20 (type: rw)	01h	Last error	02h	Penultimate error	:		14h	First of the last 20 errors
Sub	Contents															
00h	Number ≤ 20 (type: rw)															
01h	Last error															
02h	Penultimate error															
:																
14h	First of the last 20 errors															
1008h	<i>Manufacturer device name</i>	ro	STR	Product name in ASCII code												
1009h	<i>Hardware version</i>	ro	STR	E.g. "1.01"												
100Ah	<i>Software version</i>	ro	STR	e.g. "3.05"												
100Ch	<i>Guard time – Node monitoring time</i>	rw	U16	The node guarding function is obsolete; CiA recommends the usage of the heartbeat function (Consumer / Producer), → Object 1016h / 1017h.												
100Dh	<i>Life time factor</i>	rw	U16													
1010h	<i>Store parameters (power failure-proof)</i>	rw	U32	<p>Transfer the parameter values from RAM to the flash memory</p> <ul style="list-style-type: none"> Write Write code word "save" in reverse notation (65766173h) to the related subindex Read The value 1 is always output <table border="1"> <thead> <tr> <th>Sub</th> <th>Contents</th> </tr> </thead> <tbody> <tr> <td>00h</td> <td>Number of save options = 4 (type: ro)</td> </tr> <tr> <td>01h</td> <td>All parameters</td> </tr> <tr> <td>02h</td> <td>Only communication parameters (CiA 301)</td> </tr> <tr> <td>03h</td> <td>Only device parameters (CiA 401), <i>not used</i></td> </tr> <tr> <td>04h</td> <td>Only manufacturer-specific parameters, <i>not used</i></td> </tr> </tbody> </table>	Sub	Contents	00h	Number of save options = 4 (type: ro)	01h	All parameters	02h	Only communication parameters (CiA 301)	03h	Only device parameters (CiA 401), <i>not used</i>	04h	Only manufacturer-specific parameters, <i>not used</i>
Sub	Contents															
00h	Number of save options = 4 (type: ro)															
01h	All parameters															
02h	Only communication parameters (CiA 301)															
03h	Only device parameters (CiA 401), <i>not used</i>															
04h	Only manufacturer-specific parameters, <i>not used</i>															

Index	Designation	Acc.	Type	Meaning												
1011h	<i>Restore default parameters</i>	rw	U32	<p>Device parameters are reset to their factory settings, not to the values saved using object 1010h</p> <ul style="list-style-type: none"> Write Write code word “load” in reverse notation (64616F6Ch) to the related sub-index Read The value 1 is always output <table border="1"> <thead> <tr> <th>Sub</th> <th>Contents</th> </tr> </thead> <tbody> <tr> <td>00h</td> <td>Number of reset options = 4 (type: ro)</td> </tr> <tr> <td>01h</td> <td>All parameters</td> </tr> <tr> <td>02h</td> <td>Only communication parameters (CiA 301)</td> </tr> <tr> <td>03h</td> <td>Only device parameters (CiA 401), <i>not used</i></td> </tr> <tr> <td>04h</td> <td>Only manufacturer-specific parameters, <i>not used</i></td> </tr> </tbody> </table>	Sub	Contents	00h	Number of reset options = 4 (type: ro)	01h	All parameters	02h	Only communication parameters (CiA 301)	03h	Only device parameters (CiA 401), <i>not used</i>	04h	Only manufacturer-specific parameters, <i>not used</i>
Sub	Contents															
00h	Number of reset options = 4 (type: ro)															
01h	All parameters															
02h	Only communication parameters (CiA 301)															
03h	Only device parameters (CiA 401), <i>not used</i>															
04h	Only manufacturer-specific parameters, <i>not used</i>															
1016h	<i>Consumer Heartbeat time – Repetition time of the master in ms</i>	rw	U32	<p>The heartbeat function (1016h/1017h) should be used instead of node guarding (100Ch/100Dh) according to CiA recommendations.</p> <table border="1"> <thead> <tr> <th>Sub</th> <th>Contents</th> </tr> </thead> <tbody> <tr> <td>00h</td> <td>Number of values = 127 (type: ro)</td> </tr> <tr> <td>01h ⋮ 7Fh</td> <td>Master node number (bits 23–16) and repetition time (bits 15–0)</td> </tr> </tbody> </table> <p>Recommended time setting: Heartbeat Consumer = 3× Heartbeat Producer (1017h)</p>	Sub	Contents	00h	Number of values = 127 (type: ro)	01h ⋮ 7Fh	Master node number (bits 23–16) and repetition time (bits 15–0)						
Sub	Contents															
00h	Number of values = 127 (type: ro)															
01h ⋮ 7Fh	Master node number (bits 23–16) and repetition time (bits 15–0)															
1017h	<i>Producer Heartbeat time – Repetition time of the device in ms</i>	rw	U16	Value ≠ 0 deactivates node guarding												

Index	Designation	Acc.	Type	Meaning	
1018h	<i>Identity object – Object identification</i>	ro	U32	Sub	Contents
				00h	Number of IDs = 4
				01h	Manufacturer's ID: 1C5h
				02h	Product code: 3011C0h
				03h	Revision no.: e.g. 00000002h
				04h	Serial no.: xxxxxxxxh
1800h	<i>1st transmit PDO parameter – TxPDO1 configuration</i>	rw	U32	Sub	Contents
				00h	Number of IDs = 5 (type: ro)
				01h	COB ID used by PDO (default: 180h + node ID)
				02h	Transmission type for the PDO (default: 01h, cyclic)
				03h	Minimum waiting time for the PDO (in ms)
				04h	Not used
				05h	Event timer for the PDO (in ms), after the time has elapsed the PDO is sent automatically
1801h	<i>2nd transmit PDO parameter – TxPDO2 configuration</i>	rw	U32	Only in conjunction with a second customer-specific filter; structure as before	
1A00h	<i>1st transmit PDO mapping – TxPDO1 mapping</i>	ro	U32	Sub	Contents
				00h	Number of entries = 5
				01h	1st application object: acceleration X axis (64010110h)
				02h	2nd application object: acceleration Y axis (64010210h)
				03h	3rd application object: acceleration Z axis (64010310h)
				04h	4th application object: relay status (60000108h)
05h	5th application object: heartbeat counter (64000108h)				

Index	Designation	Acc.	Type	Meaning	
1A01h	2nd transmit PDO mapping – TxPDO2 mapping	ro	U32	Only in conjunction with a second customer-specific filter:	
				Sub	Contents
				00h	Number of entries = 5
				01h	1st application object: Acceleration X axis (64010410h)
				02h	2nd application object: Acceleration Y axis (64010510h)
				03h	3rd application object: Acceleration Z axis (64010610h)
				04h	4th application object: relay status (60000108h)
05h	5th application object: heartbeat counter (64000108h)				

TxPDO structure for filter 1 (1A00h)

2 bytes	2 bytes	2 bytes	1 byte	1 byte
X acceleration	Y acceleration	Z acceleration	Status	hb counter
Object 6401h Sub 1	Object 6401h Sub 2	Object 6401h Sub 3	Object 6000h Sub 1	Object 6400h Sub 2

hb = heartbeat

TxPDO structure for filter 2 (1A01h)

2 bytes	2 bytes	2 bytes	1 byte	1 byte
X acceleration	Y acceleration	Z acceleration	Status	hb counter
Object 6401h Sub 4	Object 6401h Sub 5	Object 6401h Sub 6	Object 6000h Sub 1	Object 6400h Sub 2

hb = heartbeat

3.2 Device parameters in accordance with CiA 401 (6xxxh)

Index	Designation	Acc.	Type	Meaning	
6000h	Relay status	ro	U8	Sub	Contents
				00h	Number of entries = 1
				01h	Bit 0: Sensor error (1) Bit 1: Sensor deviation (1) Bit 2: Limit exceeded (1) Bit 3: Relay fault (1) Bit 4: System fault (1) Bit 5: Safety circuit closed (1)
6400h	Heartbeat counter	ro	S8	Sub	Contents
				00h	Number of entries = 1
				01h	Heartbeat counter (0...255)
6401h	Actual acceleration	ro	S16	Sub	Contents
				00h	Number of entries = 6
				01h	In X direction (filter 1)
				02h	In Y direction (filter 1)
				03h	In Z direction (filter 1)
				04h	In X direction (filter 2)
				05h	In Y direction (filter 2)
				06h	In Z direction (filter 2)
				Values in 1/100 m/s ²	

3.3 Manufacturer-specific objects (2xxxh)

Index	Designation	Acc.	Type	Meaning	
2016h	Trigger values (customer-specific)	ro	S16	Sub	Contents
				00h	Number of entries = 8
				01h	Acceleration in -X direction
				02h	Acceleration in +X direction
				03h	Acceleration in -Y direction
				04h	Acceleration in +Y direction
				05h	Acceleration in -Z direction ⁽¹⁾
				06h	Acceleration in +Z direction ⁽¹⁾
				07h	Limit for geometric sum
				08h	Measuring characteristic: 0 = axis-related 1 = geometric sum
2017h	Relay inhibit time	ro	U16	30 s (1Eh)	
2201h	Self-test	rw	U8	Write: 0→1 = Start	

⁽¹⁾ This entry is provided for a future expansion – it always provides the value 0.

4 SDO communication

The service data objects (SDO) form the communication channel for the transmission of device parameters. As these parameters are transmitted acyclically (e.g. only once on booting the network), the SDOs have a lower priority (high COB identifier).

Structure of the SDO message

COB ID	DLC	Byte 1	Byte 2	Byte 3	Byte 4	Byte 5	Byte 6	Byte 7	Byte 8
SDO identifier	Data length	Com-mand	Index L	Index H	Subin-dex	Data 0	Data 1	Data 2	Data 3

The SDO identifier is defined as follows:

Client (control system) → Server (absolute rotary encoder): **600h + node ID**

Server (absolute rotary encoder) → Client (control system): **580h + node ID**

The data length (DLC) is always 8: 1 command byte + 2 index bytes (object) + 1 sub-index byte + 4 data bytes

The command defines whether data are to be written (download) or read (upload) and the number of user data bytes:

Com-mand	Description	User data	Function
22h	SDO(rx), Download Request	Undefined	Send parameters to the Sensor
23h		4 bytes	
2Bh		2 bytes	
2Fh		1 byte	
60h	SDO(tx), Download Response	—	Confirm parameter acceptance to the client
40h	SDO(rx), Upload Request	—	Request parameters from the Sensor
42h	SDO(tx), Upload Response	Undefined	Send parameters to the client
43h		4 bytes	
4Bh		2 bytes	
4Fh		1 byte	
80h	SDO(tx), Abort Domain Transfer (abort due to error)	4 bytes	Sensor signals error code to the client

In the case of an error, an error message with the command 80h (SDO Abort Message) replaces the normal confirmation (response). Index and subindex belong to the object stated previously. The error code (Abort code) is given in bytes 5 to 8:

Abort codes	Fault
05040001h	Command byte is not supported
06010000h	Incorrect access to an object
06010001h	Read access to a write-only object
06010002h	Write access to a read-only object
06020000h	Object is not supported
06090011h	Subindex is not supported
06090030h	Parameter value outside the limits
06090031h	Parameter value too high
06090032h	Parameter value too low
08000000h	General error
08000020h	Incorrect memory signature ("save")
08000021h	Not possible to save parameters

5 Emergency messages

5.1 Allgemein

Im Fehlerfall wird über die *COB-ID EMCY*-Meldung ein Notfall-Telegramm ausgegeben.

Es besteht aus einem 8-Byte-Alarmobjekt für die Signalisierung von Fehlermeldungen mit einem 2-Byte-Fehlercode nach CiA 301 und dem 1-Byte-Fehlerregister.

Die geräteinterne Fehlerliste kann über das Objekt 1003h (Vordefiniertes Fehlerfeld) ausgelesen werden. Das Fehlerregister signalisiert durch einen Wert $\neq 0$ (aus Objekt 1001h) das Vorhandensein eines Gerätefehlers.

Telegrammaufbau

COB-ID	DLC	Byte 1	Byte 2	Byte 3	Byte 4	Byte 5	Byte 6	Byte 7	Byte 8
80h+Node-ID	8	Fehlercode		Fehlerregister	<i>reserviert</i>				

5.2 Error codes

Error code	Fault
0000h	No fault
5000h	General hardware fault
5010h	Self-test failed
5030h	Sensor error
8130h	Lifeguarding fault

6 LSS functions

Using LSS the node ID and baud rate can be set via the CAN bus. The protocol is described in CiA 305 *Layer Setting Services (LSS)*.

Preconditions

- 1:1 connection from the device to the node
- Device has not yet received an “NMT-Start-Node”
- Node uses the same baud rate as the device.

The node address and the baud rate are set in the *dialog mode*. A CAN message is sent to the device via the COB ID 07E5h (2021) and the device replies with the COB ID 07E4h (2020).

After the COB ID, an LSS *Command Specifier (CS)* and 7 data bytes are sent.

Protocol structure:

COB ID	CS	Byte 1	Byte 2	Byte 3	Byte 4	Byte 5	Byte 6	Byte 7
--------	----	--------	--------	--------	--------	--------	--------	--------

COB ID :

LSS master → LSS slave: **07E5h**

LSS slave → LSS master: **07E4h**

Switch State Global Protocol

Using this service an LSS master can communicate with an individual slave. A related LSS address does not need to be known. The slave is configured with the aid of a LSS configuration tool.

To configure the device, the *Switch Mode Global Command* is transferred. This command sets the device in the configuration mode.

LSS master → LSS slave

COB ID	CS	Byte 1	Byte 2	Byte 3	Byte 4	Byte 5	Byte 6	Byte 7
07E5h	04h	Mode	Reserved					

Mode:

0 → Operation

1 → Configuration

If the device is in the configuration mode, the node number can be set using the [Configure Node-ID](#) service. The baud rate is set using [Configure Bit Timing Parameter](#).

Two setting parameters are transferred using [Configure Bit Timing Parameter](#): “Table_Selector” and “Table_Index”. Table_Selector defines the baud rate table to be used. The default baud rate table from the CiA (CiA102) with the value 0 is used for reference. The required baud rate is then selected from the table using Table_Index (→ [page 20](#)).

The settings are saved using the [Store Configuration](#) service. Then you can return to the LSS state Operation. (→ [page 20](#))

There is no confirmation for the LSS service *Switch Mode Global Command* even if it has been run. Whether the baud rate for the master has been set to that of the slave can be checked, for example, using the *Inquire Node-ID* service (05Eh).

If the baud rate for the master and the device have been configured correctly, the node ID is sent as a reply. If a reply is not sent, the baud rate is not set correctly or the fieldbus is operating incorrectly (e.g. due to cable break or missing/faulty terminating resistor). If the baud rate is not known, all permissible baud rates must be tested using this service. (See bit timing table, → [page 20](#))

6.1 Setting node number (*Configure node ID*)

LSS master → LSS slave

COB ID	CS	Byte 1	Byte 2	Byte 3	Byte 4	Byte 5	Byte 6	Byte 7
07E5h	11h	Node ID	Reserved					

LSS slave → LSS master

COB ID	CS	Byte 1	Byte 2	Byte 3	Byte 4	Byte 5	Byte 6	Byte 7
07E4h	11h	ErrCode	SpecError	Reserved				

Explanations:

Node ID: New node number for the device (1...126)

ErrCode: Error number: 0 = OK, 1 = node ID outside the range allowed, 2...
254 = reserved, 255 = application-specific error

SpecCode: Application-specific error number if ErrCode = 255

6.2 Setting baud rate (*Configure Bit Timing Parameter*)

LSS master → LSS slave

COB ID	CS	Byte 1	Byte 2	Byte 3	Byte 4	Byte 5	Byte 6	Byte 7
07E5h	13h	TableSel	TableInd	Reserved				

LSS slave → LSS master

COB ID	CS	Byte 1	Byte 2	Byte 3	Byte 4	Byte 5	Byte 6	Byte 7
07E4h	13h	ErrCode	SpecError	Reserved				

Explanations:

TableSel: Selects the bit timing table: 0 = default CiA bit timing table, 1...127 = reserved for CiA, 128...255 = manufacturer-specific tables

TableInd: Index for the required entry in the selected table (see below)

ErrCode: Error number: 0 = OK, 1 = bit timing not supported, 2 to 254 = reserved, 255 = application-specific error

SpecCode: Application-specific error number if ErrCode = 255

CiA bit timing table:

Baud rate in Kbit/s	10	20	50	100	125	250	500	800	1000
Index	8	7	6	5	4	3	2	1	0

6.3 Writing settings to the flash memory (*Store Configuration*)

LSS master → LSS slave

COB ID	CS	Byte 1	Byte 2	Byte 3	Byte 4	Byte 5	Byte 6	Byte 7
07E5h	17h	Reserved						

LSS slave → LSS master

COB ID	CS	Byte 1	Byte 2	Byte 3	Byte 4	Byte 5	Byte 6	Byte 7
07E4h	17h	ErrCode	SpecError	Reserved				

ErrCode: Error number: 0 = OK, 1 = product cannot save data, 2 = memory access error, 3 to 254 = reserved, 255 = application-specific error

SpecCode: Application-specific error number if ErrCode = 255