

# MiniCODER

Magnetic absolute encoder kit system  
with additional incremental output

# GEL 2800

Technical Information

Version 02-2019

## General

- Magnetic absolute single turn encoder kit
- Bearingless mounting kit consists of a scanning unit and a ferromagnetic measuring scale (toothed wheel)
- Rotational speed and position acquisition by means of contactless scanning of a two-track toothed wheel
- Calculation of the absolute position via Vernier evaluation
- Suitable for usage in harsh environmental conditions, as fully encapsulated electronics
- Due to the self-calibration, robust in relation to mechanical tolerances
- Magnetic brakes or the motor winding do not affect the measuring system

## Features

- Resolution of 18 bits <sup>(1)</sup>
- Output signals
  - Position: Configurable interface SSI
  - Rotational speed: Incremental output
- Absolute accuracy up to  $\pm 0.05^{\circ(2)}$
- Temperature range  $-40\text{ }^{\circ}\text{C}$  to  $+105\text{ }^{\circ}\text{C}$
- Degree of protection IP 68

## Advantages

- Maintenance and wear-free, as the system does not require dedicated bearings
- Quick customer-specific adaptation by selecting the module and inside diameter of the toothed wheel
- Safe installation and easy commissioning by on-site adjustment of scanning unit and measuring scale as well as parameter configuration by means of testing and programming unit

## Field of application

- Drive technology
- Special purpose machine construction



(1) on delivery with standard parameters

(2) without consideration of the mounting tolerances

*Right to technical changes and errors reserved.*

# Description

## Construction and design

The measuring unit comprises a magnetic absolute single turn built-in encoder and a ferromagnetic measuring scale (toothed wheel). The measuring scale is mounted directly on the drive shaft.

The encoder provides unambiguous position values at every angular position, optionally as a binary or gray code using the SSI protocol. It also outputs incremental signals with HTL or TTL levels for the rotational speed measurement.

The measuring system is extremely robust and also operates correctly even close to a magnetic brake or motor winding. This aspect eases the integration in the application. Dust, humidity and oil do not affect the magnetic measuring system, therefore, it is particularly suitable for harsh industrial environments.

## Sensing principle

The encoder kit contactlessly scans a two-track target wheel with different numbers of teeth. One track has the tooth number  $Z$ , the other  $(Z-1)$ . The giant magnetoresistive (GMR) sensors provide the corresponding sinusoidal signals for both tracks. These are interpolated in the sensor, in this way the system generates high internal pulse counts.

The phase position of the two tracks  $Z$  and  $(Z-1)$  in relation to each other is evaluated by the electronics based on the vernier principle. The phase position is unambiguous within one turn and in this way the system calculates the absolute position via the internal pulse counts.

## Incremental output

From the interpolated sin/cos signals, the encoder generates two square-wave signals with a phase offset of  $90^\circ$  (tracks A and B) and their inverse signals. The high internal number of pulses is divided by a configurable factor; the result of this division is a reduced number of pulses. The encoder outputs the signals with HTL or TTL level depending on the supply voltage.

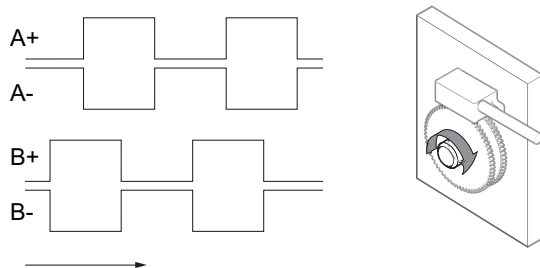

## Serial data transmission

The serial interface transmits the position data with a clock frequency of up to 500 kHz. Before further position sampling, a minimum clock pulse space of  $16 \mu\text{s}$  must be met.

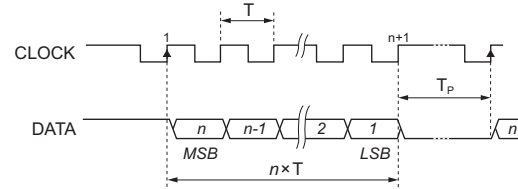

Principle of serial data transmission [RS 422 / RS 485 standard]

- f Clock frequency ( $> 62,5 \text{ kHz}$ )
- T Clock signal period ( $= 1/\text{clock frequency}$ )
- $T_p$  Clock pulse space, between the clock sequences,  $T_p$  at least  $16 \mu\text{s}$

The length of the SSI data word depends on the total resolution of the encoder.

## Output of the position data

The encoder outputs increasing position values with the clockwise rotation of the shaft.

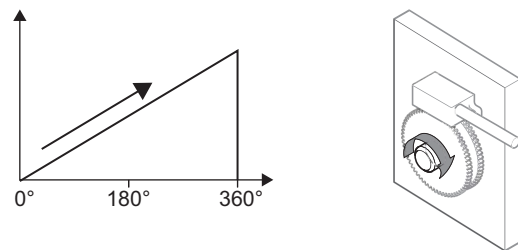

## PRESET input

The output signals can be set to a preset value from any position value. The value is set using the PRESET input or using a software command. The preset function can be configured using the testing and programming unit. On delivery, the device is configured so that a high level is required to trigger the preset. With this configuration the preset is set electronically if  $U_B$  is briefly applied to the Preset input for  $t > 1 \text{ s}$ . Do NOT apply continuously.

## ERROR input

The encoder internally checks the continuity of the position data. If steps occur in the position data during operation, the ERROR input is set high for a short time. An error can generally be rectified by checking and optimising the system with the aid of the testing and programming unit.

## Cable length

With the serial interface protocol the transmission rate allowed drops with increasing cable length. A screened, twisted pair cable is recommended for the signal cables ( $\pm$  CLOCK and  $\pm$  DATA).

Cable length [m]	< 50	< 100	< 200	< 400
Clock frequency [kHz]	< 400	< 300	< 200	< 100

## Optional extra: Parametrizable (P)

The built-in encoder can be configured using the testing and programming unit.

### Default parameters (on delivery)

Parameter		Function	Default	Significance
<i>IPO Periods</i>	Number of teeth <sup>(1)</sup>	Define the internal pulse counts during position acquisition	64	→ $64 \times 4096$ = 262144 steps per 360° ≙ 18-bit total resolution
<i>IPO Rate</i>	Interpolation factor		4096	
<i>ABZ Impulse Divider</i>	Division factor	Reduces the pulse number for the incremental output	8	262144 steps per 360° / 8 ≙ 32768 pulses per revolution
<i>Preset Type</i>	Preset trigger	Sets the trigger for the preset	Active high input signal	
<i>Position value Coding</i>	Type of code	Defines the output code for the position values	Binary code (SSI)	

## Preferred toothed wheels

	1	2	3	4
<b>Toothed wheel</b>				
Item №	ZFD164xxx	ZFD264xxx	ZFD364xxx	ZFD464xxx
Number of teeth	64/63			
Outer diameter (OD)	65 mm	130 mm	195 mm	260 mm
Maximum inner diameter	45.5 mm	91 mm	136.5 mm	182 mm
Permissible air gap	0.5 mm	1.0 mm	1.5 mm	2.0 mm
Width	≥ 14.0 mm			
Material	ferromagnetic steel			

<sup>(1)</sup> Tooth wheel with 64/63 teeth, adaptation is required for other numbers of teeth.

# Technical data

<b>General data</b>	
Repeat accuracy	$\pm 0.01^{(1)}$
Accuracy	up to $\pm 0.05^{(1)}$
Steps per revolution	262,144 <sup>(2)</sup>
Total resolution	18 bits <sup>(2)</sup>
<b>Electrical data</b>	
Supply voltage $U_B$	5 V to 30 V DC
Power consumption	< 300 mA
Dielectric strength	500 V, in accordance with EN 61439-1
<b>Incremental output</b>	
Output signals	A+ / A- / B+ / B-
Number of pulses (pulses per revolution)	configurable by division factor
Output signal level	HTL (TTL at $U_B = 5$ V DC)
Output frequency	0 to 200 kHz <sup>(3)</sup>
<b>Synchron serielle Schnittstelle</b>	
Protocol	SSI (binary or gray code)
Maximum clock frequency	500 kHz
Driver	RS 485 compatible
Preset	Set via input level or software command
<b>Mechanical data</b>	
Degree of protection	IP 68
Weight sensor	30 g
Housing material	Stainless steel
<b>Environmental conditions</b>	
Assured operating temperature range	-40 °C to +105 °C
Operating and storage temperature range	-40 °C to +105 °C
Vibration resistance	200 m/s <sup>2</sup> , in accordance with DIN EN 60068-2-6
Shock resistance	2000 m/s <sup>2</sup> , in accordance with DIN EN 60068-2-27
Electromagnetic compatibility	EN 61000-6-1 to 4
MTTF value	1,173,433 h <sup>(4)</sup>
FIT value	$852 \times 10^{-9} \text{ h}^{-1}$ <sup>(4)</sup>
<b>Cable data</b>	
Cable	halogenfree and screened <sup>(5)</sup>
Cable diameter	7.5 -0,4 mm
Cross section	$6 \times 2 \times 0.15 \text{ mm}^2$
Minimum bending radius static/dynamic	15 mm / 38 mm

(1) without consideration of the mounting tolerances

(2) on delivery with standard parameters

(3) The maximum output frequency depends on the working temperature, supply voltage and the cable capacitance.

(4) at a reference temperature of 55°C

(5) specification upon request

# Dimensional drawing

All dimensions in mm, general tolerance DIN ISO 2768 -mK

## Dimensional drawings GEL 2800

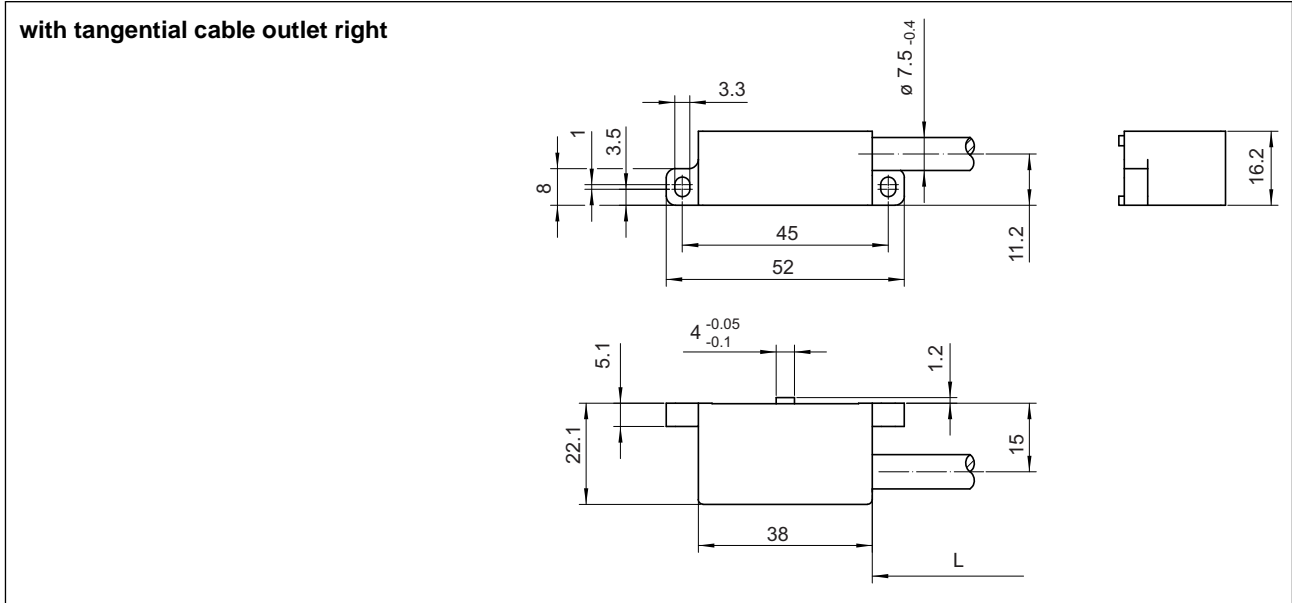

## Connection type

<b>K</b> (flying lead)		Cable lengths available: <b>030 / 050 / 150 // 200 / 250 / 400 / 600 / 700</b>
<b>L</b> (M23 connector coupling; 17 pin)		Cable lengths available: <b>030 / 050 / 150 // 200 / 250 / 400 / 600 / 700</b>

L Cable length as per type code

## Boring and milling sketch

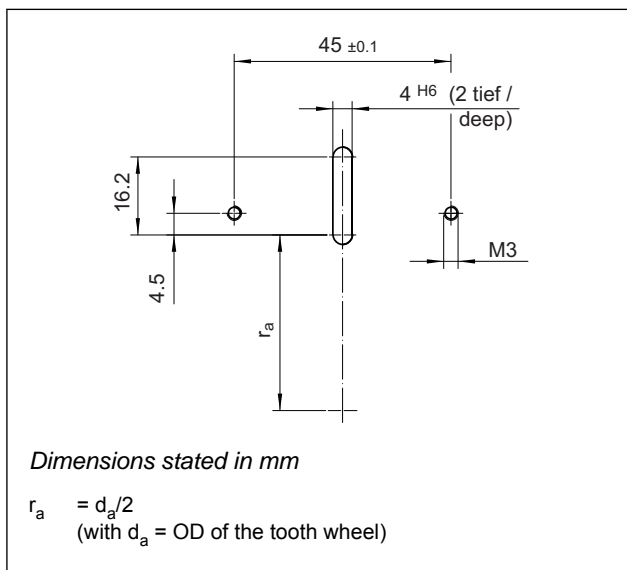

## Assembly drawing

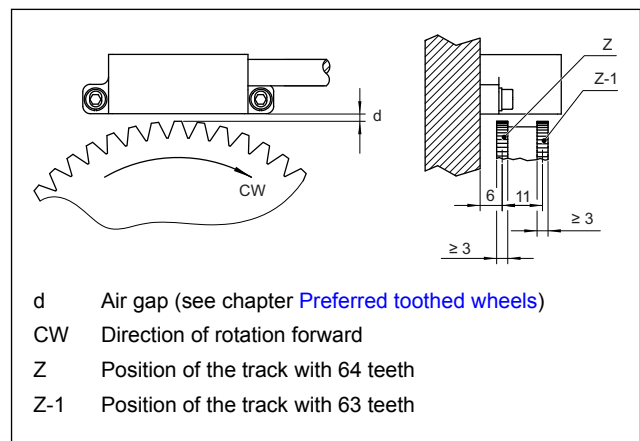

# Connection assignment

## Connection type K

flying lead	Core	Signal / function	
	GN	A+	incremental signal track A
	YE	A-	inverse incremental signal track A
	OG	CLOCK+	input: Differential clock signal in accordance with RS 485
	BE	CLOCK-	
	PK	Preset	set measuring range zero
	BU	GND	ground
	RD	U <sub>B</sub>	supply voltage
	BK	B+	incremental signal track B
	VT	B-	inverse incremental signal track B
	BN	DATA+	output: Differential data signal in accordance with RS 485
	WH	DATA-	
	GR	Error	error output, isolate core when not in use

Core colour code:  
**BK** black, **BE** beige, **BN** brown, **BU** blue, **GN** green, **GY** grey, **OG** orange, **PK** pink, **RD** red, **VT** violet, **WH** white, **YE** yellow

## Connection type L

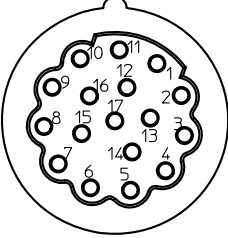
M23 connector coupling; 17 pin	Pin	Signal / function	
	1	A+	incremental signal track A
	2	A-	inverse incremental signal track A
	3		<i>reserved</i>
	4	CLOCK+	input: Differential clock signal in accordance with RS 485
	5	CLOCK-	
	6	Preset	set measuring range zero
	7	GND	ground
	8; 9		<i>reserved</i>
	10	U <sub>B</sub>	supply voltage
	11	B+	incremental signal track B
	12	B-	inverse incremental signal track B
	13		<i>reserved</i>
	14	DATA+	output: Differential data signal in accordance with RS 485
	15	DATA-	
	16; 17		<i>reserved</i>

## Type code for scanning unit GEL 2800

<b>2800</b>	<b>Interface</b>		
	<b>S</b>	Standard: SSI, binary code (configurable)	
	<b>M</b>	Serial interface (Mitsubishi High Speed Serial Interface <u>in preparation</u> )	
	<b>Module</b>		
	<b>1</b>	For toothed wheels with module 1	
	<b>2</b>	For toothed wheels with module 2	
	<b>3</b>	For toothed wheels with module 3	
	<b>4</b>	For toothed wheels with module 4	
	<b>Optional extras</b>		
	<b>P</b>	Configurable scanning unit	
<b>Cable outlet</b>			
<b>T</b>	Tangential, cable outlet right (with view on the mounting surface)		
<b>Connection type</b>			
<b>K</b>	Flying lead		
<b>L</b>	M23 connector coupling, 17-pin		
<b>Cable length L</b>			
<b>030</b>	Length 0.3 m		
<b>050</b>	Length 0.5 m		
<b>120</b>	Length 1.2 m		
<b>150</b>	Length 1.5 m		
<b>200</b>	Length 2.0 m		
<b>250</b>	Length 2.5 m		
<b>600</b>	Length 6.0 m		
<b>700</b>	Length 7.0 m		

## Type code for preferred toothed wheels

<b>ZFD</b>	<b>Module</b>		
	<b>1</b>	Module 1	
	<b>2</b>	Module 2	
	<b>3</b>	Module 3	
	<b>4</b>	Module 4	
<b>Number of teeth</b>			
<b>64</b>	Vernier system with 64/63 teeth		
<b>Inner diameter</b>			
<b>xxx</b>	Inner diameter in mm		

Other toothed wheels are available upon request.

# Accessories

## Testing and programming unit GEL 211C



- Testing Lenord+Bauer sensors with serial synchronous interface and optional incremental output
- Transmitting the data via WLAN or Ethernet to terminal devices (tablet, PC etc.)
- Display of the data in a web browser, independent of the operating system

- Examination of the mounting situation and basic function of the measuring scale and absolute encoder
- Calibration of the absolute encoder
- Functions
  - Trigger the preset
  - Test of linearity
  - Display the absolute position and the incremental counter
- Parameterisation of GEL 2800
  - Parameterisation of position acquisition
  - Parameterisation of incremental output
  - Configuration of preset
  - Configuration of interface

Item no.	Description
GEL 211CSS4W2N	<ul style="list-style-type: none"> <li>▪ Testing and programming unit with WLAN interface</li> </ul>
GEL 211CSS4E2N	<ul style="list-style-type: none"> <li>▪ Testing and programming unit with Ethernet interface</li> </ul>
PK211C-2800-W	WLAN testing and programming kit <ul style="list-style-type: none"> <li>▪ Testing and programming unit GEL 211CSS4W2N</li> <li>▪ Power supply 24 V, M23 coupling</li> <li>▪ Transport case</li> </ul>
PK211C-2800-E	Ethernet testing and programming kit <ul style="list-style-type: none"> <li>▪ Testing and programming unit GEL 211CSS4E2N</li> <li>▪ Power supply 24 V, M23 coupling</li> <li>▪ Transport case</li> </ul>